

MANUAL DE USUARIO

IRONSIDE®

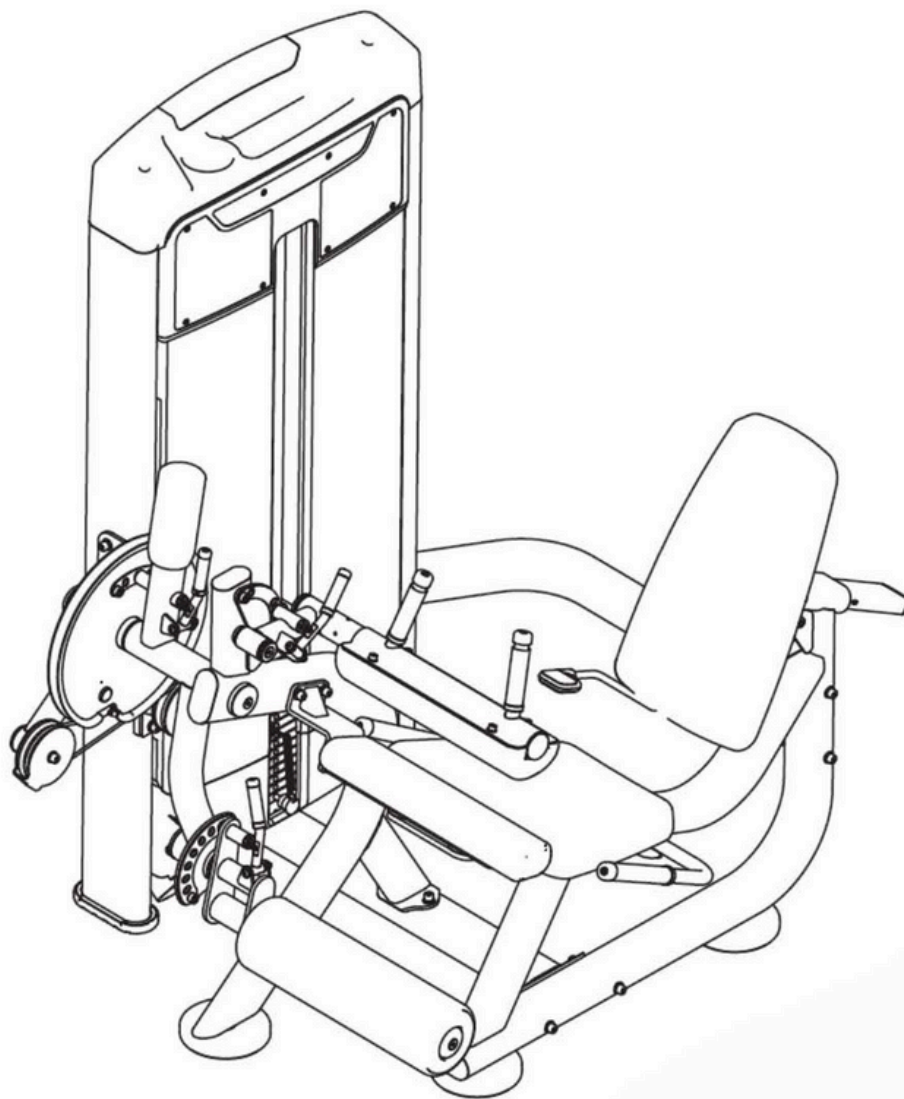

Dual Leg Curl & Extension

IRONSIDE Luxe

A081005056001

Es responsabilidad exclusiva del comprador leer el manual del propietario, las etiquetas de advertencia y dar instrucciones a todas las personas sobre el uso adecuado del equipo. Es importante comprender cada advertencia en su totalidad. Se recomienda que todos los usuarios estén informados sobre la siguiente información antes de utilizar el equipo.

ADVERTENCIAS DE SALUD

• Antes de comenzar cualquier programa de ejercicio o acondicionamiento, debes consultar con tu médico personal para determinar si necesitas un examen físico completo. Esto es especialmente importante si eres inactivo, estás embarazada o padeces alguna enfermedad.

• Si en algún momento durante el ejercicio te sientes débil, mareado o experimentas dolor, detén el ejercicio de inmediato y consulta a tu médico.

Para evitar dolores musculares y tensiones, inicia cada entrenamiento con estiramientos y calentamientos, y finaliza cada sesión enfriándote y realizando estiramientos

INSTALACIÓN

Se recomienda que todo el equipo:

• Esté asegurado o instalado sobre una superficie sólida y nivelada para estabilizarlo y eliminar movimientos o vuelcos durante el entrenamiento.

• Se instale en un lugar con ventilación suficiente para garantizar un funcionamiento adecuado.

• Se coloque con un espacio suficiente a su alrededor para que todos los ejercicios puedan realizarse de manera segura.

• Se recomienda que haya al menos 1 metro de espacio alrededor del equipo en las áreas donde se requiera acceso para ejercitarse.

USO ADECUADO

Antes de usar este equipo, por favor, lee las siguientes instrucciones de seguridad y cúmplelas. ¡Gracias!

• Ensambla el equipo siguiendo las instrucciones de montaje.

• Ten cuidado y utiliza herramientas adecuadas para el ensamblaje. Pide ayuda si encuentras algún problema.

• No uses limpiadores corrosivos para limpiarlo.

• Usa ropa y calzado adecuado para el ejercicio a fin de evitar accidentes.

• Si detectas daños en piezas pequeñas, deja de usar el equipo de inmediato y contacta con la empresa o agencia donde lo compraste para realizar el cambio. Instala las nuevas piezas correctamente y asegúrate de que las uniones y partes móviles estén bien ajustadas para evitar peligros durante su uso.

• Los padres u otros adultos supervisores deben vigilar de cerca a los niños si el equipo se usa en su presencia.









INSPECCIÓN

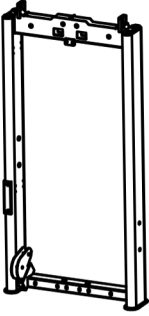
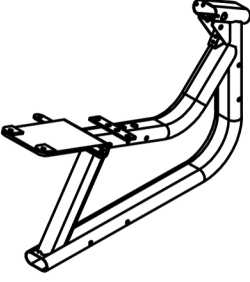
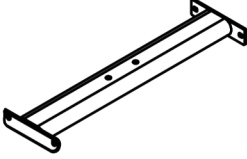
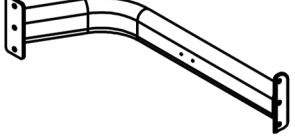

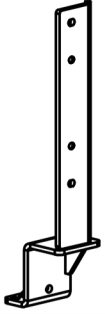
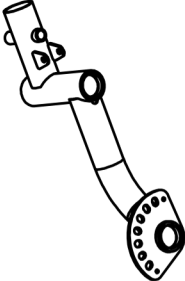

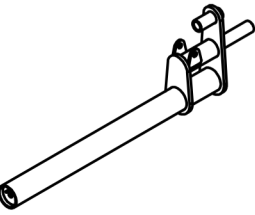
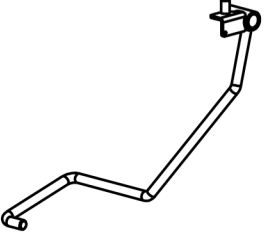

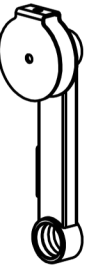
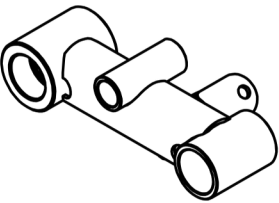
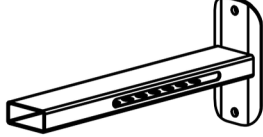
- No utilices ni permitas el uso de ningún equipo que esté dañado o tenga piezas desgastadas o rotas. Para todos los equipos de Ironside, usa únicamente piezas de repuesto suministradas por Ironside.
- Asegúrate siempre de que todas las tuercas y tornillos estén bien ajustados antes de cada uso.
- Conserva las etiquetas y placas de identificación; no las retires por ninguna razón, ya que contienen información importante.
- Mantenimiento del equipo: el mantenimiento preventivo es clave para el funcionamiento óptimo del equipo. Asegúrate de seguir nuestros consejos de mantenimiento para garantizar el correcto funcionamiento continuo de tu equipo Ironside.
- Antes de cada uso, examina todos los accesorios aprobados para su uso con el equipo Ironside en busca de daños o desgaste.
- Si tu equipo Ironside parece dañado o desgastado, no intentes usarlo ni repararlo por tu cuenta.

ADVERTENCIAS DE USO

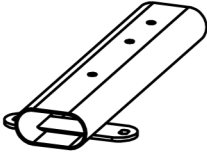
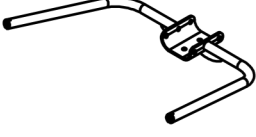
- Es responsabilidad del comprador instruir a todos los usuarios sobre los procedimientos correctos de operación de todo el equipo Ironside.
- Mantén a los niños alejados de todas las partes móviles. Los padres deben supervisar de cerca a los niños si el equipo se utiliza en su presencia.
- No uses ropa suelta ni joyas al utilizar el equipo. También se recomienda que los usuarios recojan el cabello largo para evitar el contacto con las partes móviles.
- Asegúrate de que cualquier persona que no esté utilizando el equipo se mantenga alejada del usuario, los accesorios y las partes móviles mientras la máquina esté en funcionamiento.

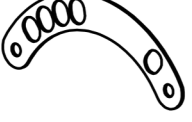
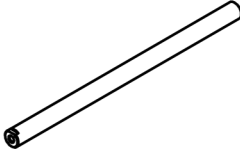
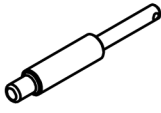
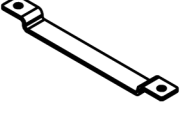
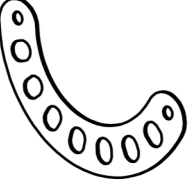
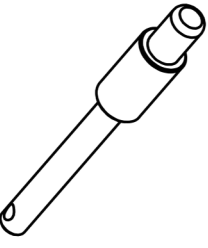
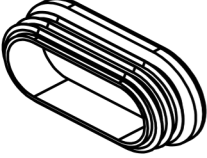
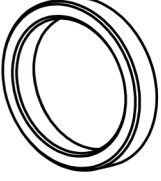
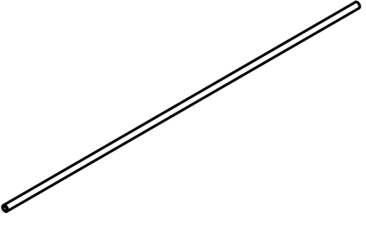

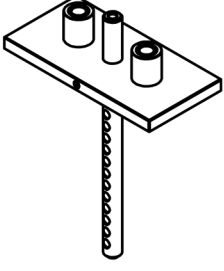

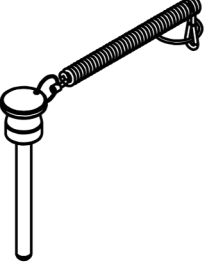

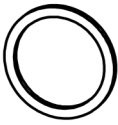
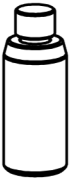

 CONSERVA ESTE MANUAL DE INSTRUCCIONES PARA USO Y REFERENCIA FUTUROS.

Marco de Torre de Pesas			Estructura del Cojín			Marco de Conexión al Suelo			Refuerzo Cruzado Trasero		
											
1		1PCS	2		1PCS	3		1PCS	4		1PCS
Soporte de Eje			Marco de Soporte			Estructura de Balanceo			Rueda de Cuerda (Polea Grande)		
											
5		1PCS	6		1PCS	7		2PCS	8		1PCS
Marco de Espuma			Marco de Manilla			Marco de Pierna			Manillar con Espuma		
											
9		1PCS	10		1PCS	11		1PCS	12		3PCS
Marco de Inversión			Marco de Ajuste			Estructura Elástica			Refuerzo Cruzado Frontal		
											
13		1PCS	14		1PCS	15		1PCS	16		1PCS

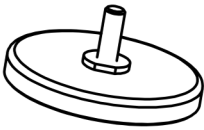
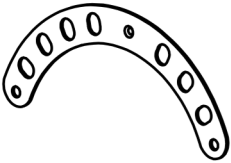
Marco de Respaldo			Conjunto de Manilla			Cable			Placa de Ajuste 1		
											
17		1PCS	18		1 PCS	19		1PCS	20		1PCS
Eje Ø25×418.5 mm			Eje Ø18.2×142 mm			Placa de Conexión			Placa de Ajuste 2		
											
21		1PCS	22		1PCS	23		1PCS	24		1PCS
Eje Ø18.2×95 mm			Tapón RT40×80 mm			Anillo de Aluminio con Espuma			Barra Guía		
											
25		2 PCS	26		1PCS	27		1PCS	28		2PCS
Buje			Placa Superior			Polea de 4.5"			Pasador de Selección		
											
29		4PCS	30		1PCS	31		4PCS	32		1PCS

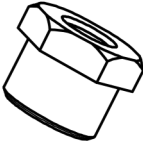
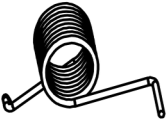



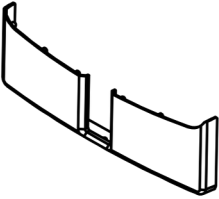
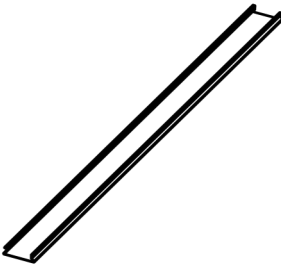
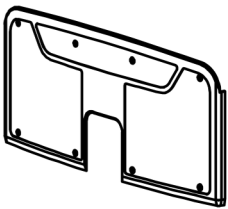



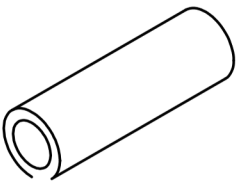
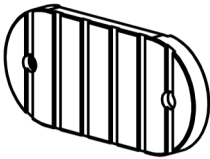
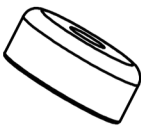

LISTA DE PIEZAS





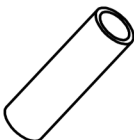
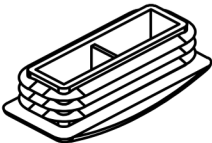
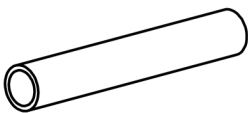

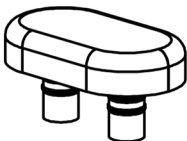
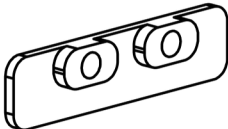

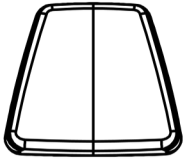
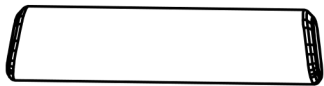
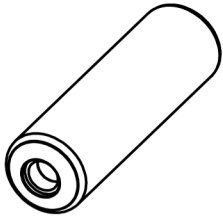

IRONSIDE®

Anillo de Agarre de Aluminio			Contrapeso			Polea de 3.5"			Refuerzo Cruzado Inferior		
											
33		2PCS	34		1PCS	35		1PCS	36		3PCS
Placa de Apoyo Ajustable			Resorte			Cadena			Tuerca de Bloqueo		
											
37		1PCS	38		3PCS	39		3PCS	40		3 PCS
Resorte de Torsión Ø30×Ø3×164 mm			Tapón de Extremo Ø38×6 mm			Polea en V			Cubierta Superior		
											
41		1PCS	42		1 PCS	43		1 PCS	44		1PCS
Cubierta Lateral			Cubierta Inferior			Hebilla Trasera			Cubierta Frontal		
											
45		4PCS	46		2 PCS	47		1 PCS	48		1 PCS

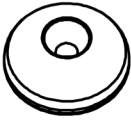
LISTA DE PIEZAS

IRONSIDE®

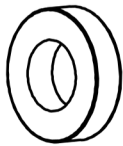
Mango Ø21×Ø14×65 mm			Pie de Goma			Manga de Goma			Tope de Goma		
											
49		3 PCS	50		2 PCS	51		2PCS	52		2PCS
Tapón RT50×100 mm			Guía de Tubo Plástico			Casquillo de Límite Ø32×Ø9 25.4×50 mm			Tapón F38		
											
53		4PCS	54		2PCS	55		2 PCS	56		2PCS
Mango Ø24×Ø31×102 mm			Tapón de Plástico			Mango Ø24×Ø31×195 mm			Espaciador Ø17×10.5 mm		
											
57		2PCS	58		3PCS	59		2PCS	60		6 PCS
Cojín Ovalado Doble			Clip de Cubierta			Parte Superior del Manillar			Parte Inferior del Manillar		
											
61		1PCS	62		8PCS	63		1 PCS	64		1 PCS

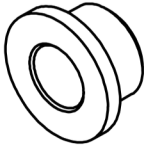
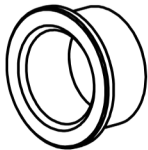
Tapón de Goma			Cojín de Pierna			Cojín de Respaldo			Cojín Abdominal		
											
65		2PCS	66		1 PCS	67		1 PCS	68		1 PCS
Cojín Frontal del Asiento			Conjunto de Espuma			Tapón de Aluminio φ22×φ17×12			Tapón de Aluminio φ22×φ17×9.5		
											
69		1PCS	70		1 PCS	71		3 PCS	72		3PCS
Tapón de Aluminio φ60×φ10.5×12.4			Tapón de Extremo φ50×8			Anillo de Aluminio φ25			Tapón de Aluminio φ32.5×φ26×19		
											
73		4PCS	74		1PCS	75		4PCS	76		4PCS
Rodamiento 6005-2Z			Casquillo φ16×φ8×8			Casquillo φ25×φ12.2×13			Casquillo φ38×φ25.4×18		
											
77		8PCS	78		6PCS	79		2PCS	80		4PCS



LISTA DE PIEZAS

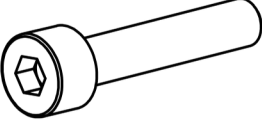
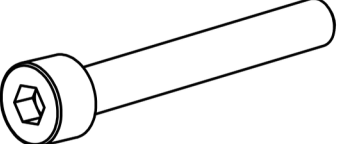
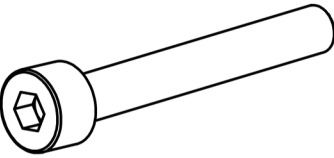
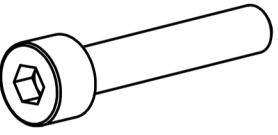
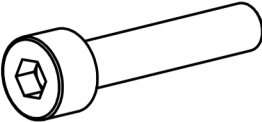
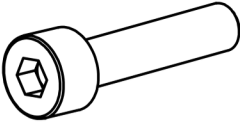
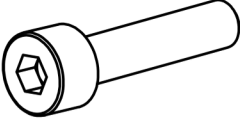
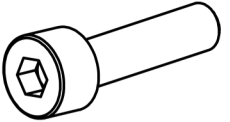
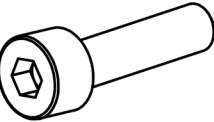
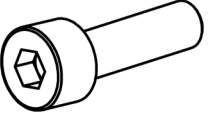
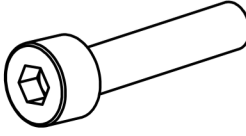
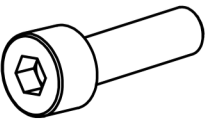
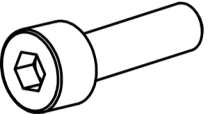
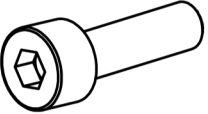
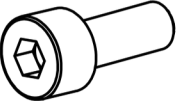
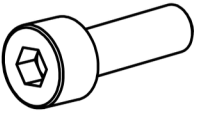



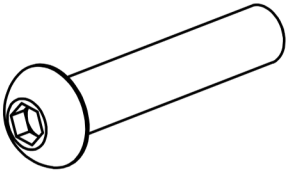
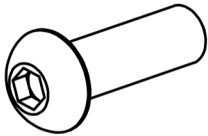
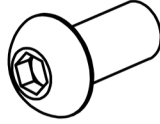
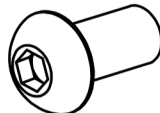
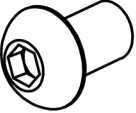
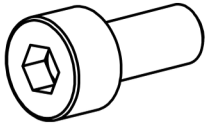
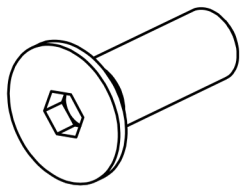
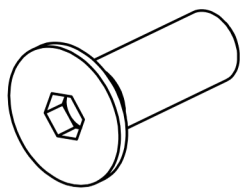
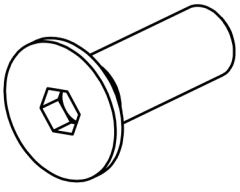
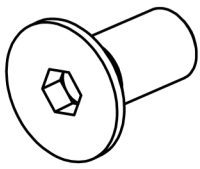
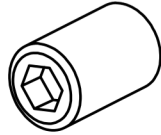

IRONSIDE®

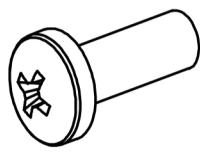
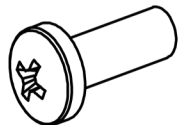
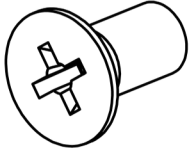
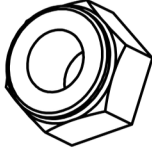
Tornillo Allen Cilíndrico M12×80			Tornillo Allen Cilíndrico M10×125			Tornillo Allen Cilíndrico M10×120			Tornillo Allen Cilíndrico M10×90		
											
81		1PCS	82		2 PCS	83		4 PCS	84		2 PCS
Tornillo Allen Cilíndrico M10×70			Tornillo Allen Cilíndrico M10×60			Tornillo Allen Cilíndrico M10×50			Tornillo Allen Cilíndrico M10×45		
											
85		4 PCS	86		1PCS	87		2PCS	88		1PCS
Tornillo Allen Cilíndrico M10×25			Tornillo Allen Cilíndrico M10×15			Tornillo Allen Cilíndrico M8×75			Tornillo Allen Cilíndrico M8×45		
											
89		12 PCS	90		1 PCS	91		1 PCS	92		1 PCS
Tornillo Allen Cilíndrico M8×30			Tornillo Allen Cilíndrico M8×25			Tornillo Allen Cilíndrico M8×10			Tornillo Allen Cilíndrico M8×20		
											
93		8 PCS	94		2 PCS	95		4 PCS	96		2 PCS

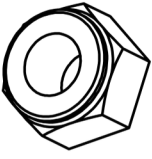
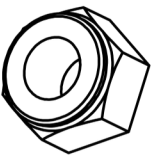
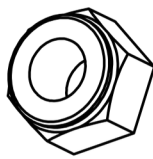
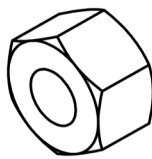
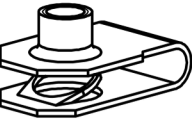
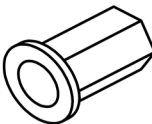
LISTA DE PIEZAS

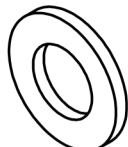
IRONSIDE®

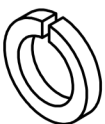
Tornillo Cabeza de Botón M8x60			Tornillo Cabeza de Botón M8x30			Tornillo Cabeza de Botón M6x12			Tornillo Cabeza de Botón M6x10		
											
97		3 PCS	98		2PCS	99		2PCS	100		12PCS
Tornillo Cabeza de Botón M5x10			Tornillo Allen Cilíndrico M4x15			Tornillo de Cabeza Avellanada M10x25			Tornillo de Cabeza Avellanada M8x30		
											
101		2PCS	102		1 PCS	103		5 PCS	104		2 PCS
Tornillo de Cabeza Avellanada M6x16			Tornillo de Cabeza Avellanada M5x10			Tornillo de Cabeza Avellanada M6x16			Tuerca de Fijación M5x3		
											
105		4 PCS	106		3 PCS	107		14 PCS	108		18PCS
Tornillo de Cabeza Phillips M5x15			Tornillo de Cabeza Phillips M4x10			Tornillo Phillips Avellanado M5x15			Tuerca de Seguridad Nylon M12		
											
109		18PCS	110		2 PCS	111		8 PCS	112		1PCS

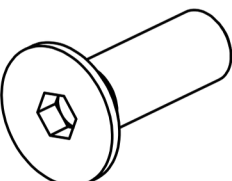
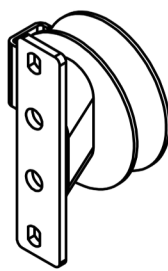
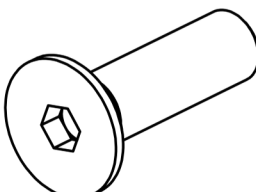
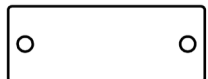
Tuerca de Seguridad Nylon M10			Tuerca de Seguridad Nylon M8			Tuerca Tipo Reed M5			Tuerca Hexagonal M6		
											
113		14PCS	114		5PCS	115		10 PCS	116		2 PCS
Soporte de Fijación Metálico			Tuerca Remachada Hexagonal de Cabeza Plana M5×13			Arandela Plana φ13×φ24×1.5			Arandela Plana φ11×φ20×2		
											
117		2PCS	118		16 PCS	119		2 PCS	120		30PCS
Arandela Plana φ9×φ16×1.6			Arandela de Resorte φ10			Arandela de Resorte φ8			Arandela Curva φ 10		
											
121		23PCS	122		12PCS	123		4 PCS	124		8PCS
Tornillo de Cabeza Avellanada M10×22			Estructura para Polea			Tornillo de Cabeza Avellanada M10×30			Placa de Identificación		
											
125		2 PCS	126		1 PCS	127		1 PCS	128		1 PCS

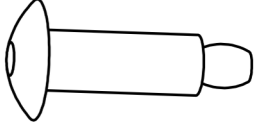
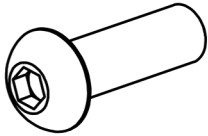
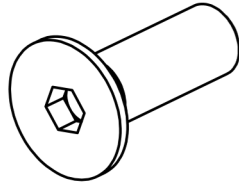
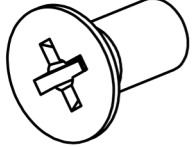
Remache			Tornillo Cabeza de Botón M8×25			Tornillo de Cabeza Avellanada M6×30			Tornillo Phillips Avellanado M4×8		
											
129		2 PCS	130		2PCS	131		2 PCS	132		1 PCS

GUÍA DE ARMADO

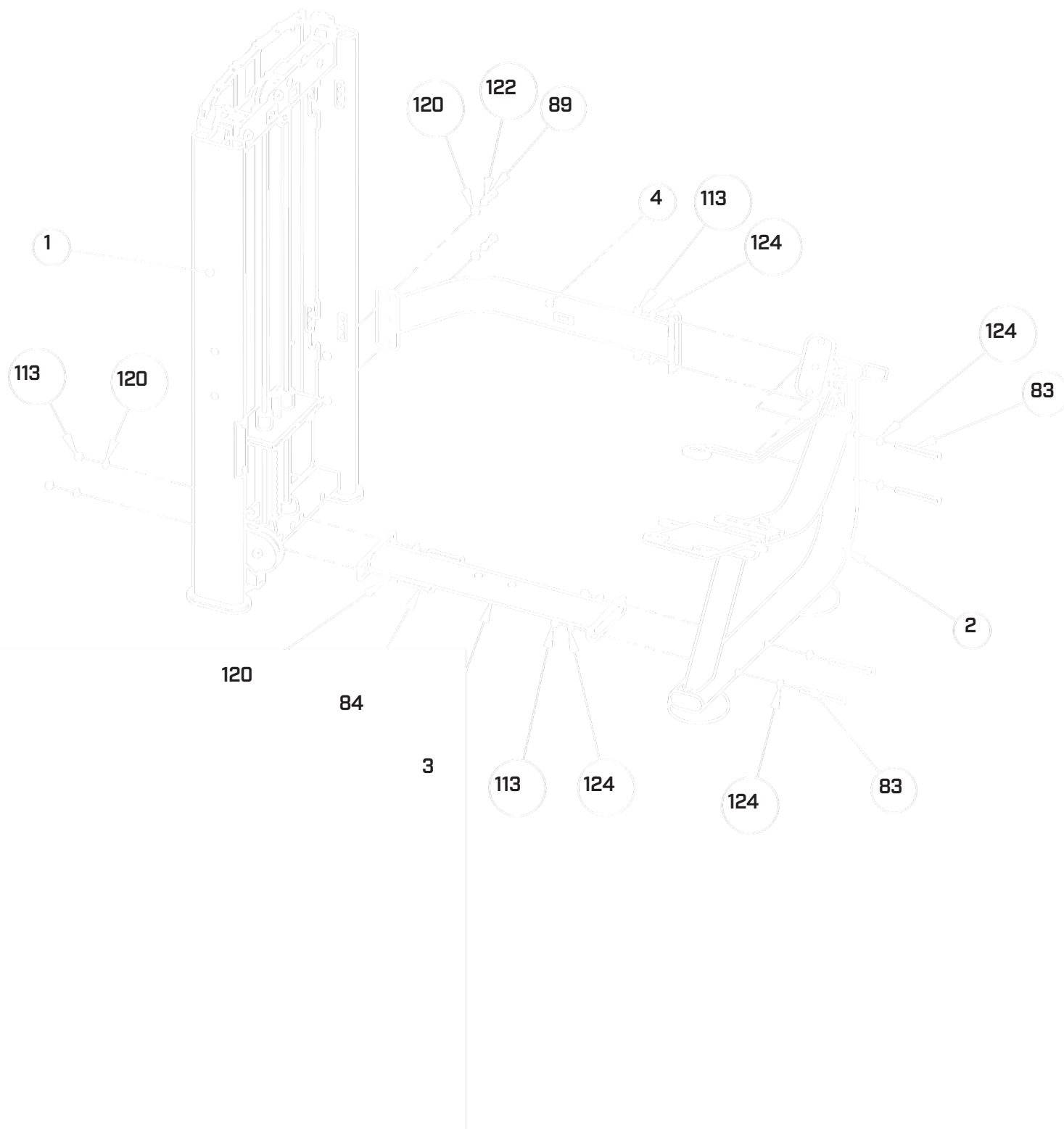

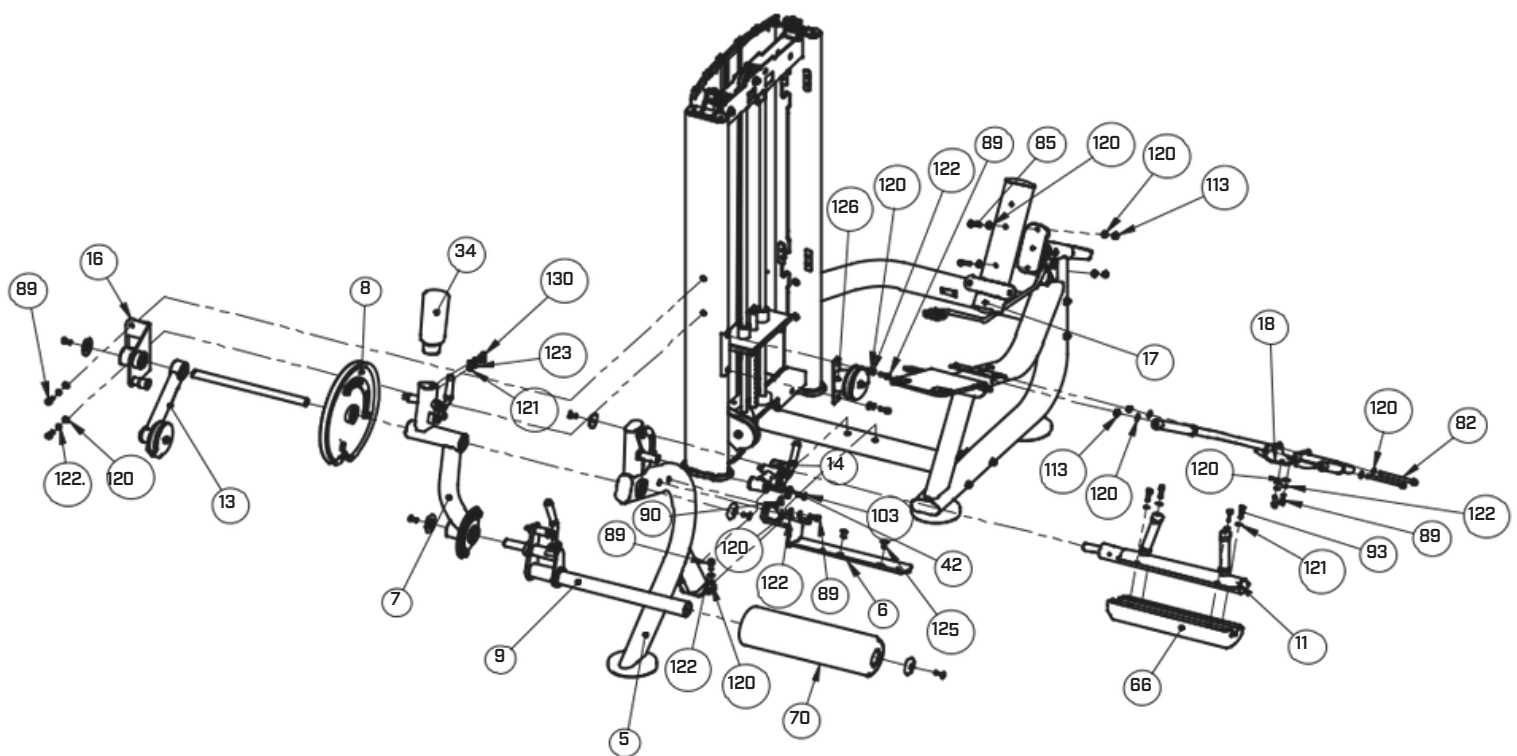

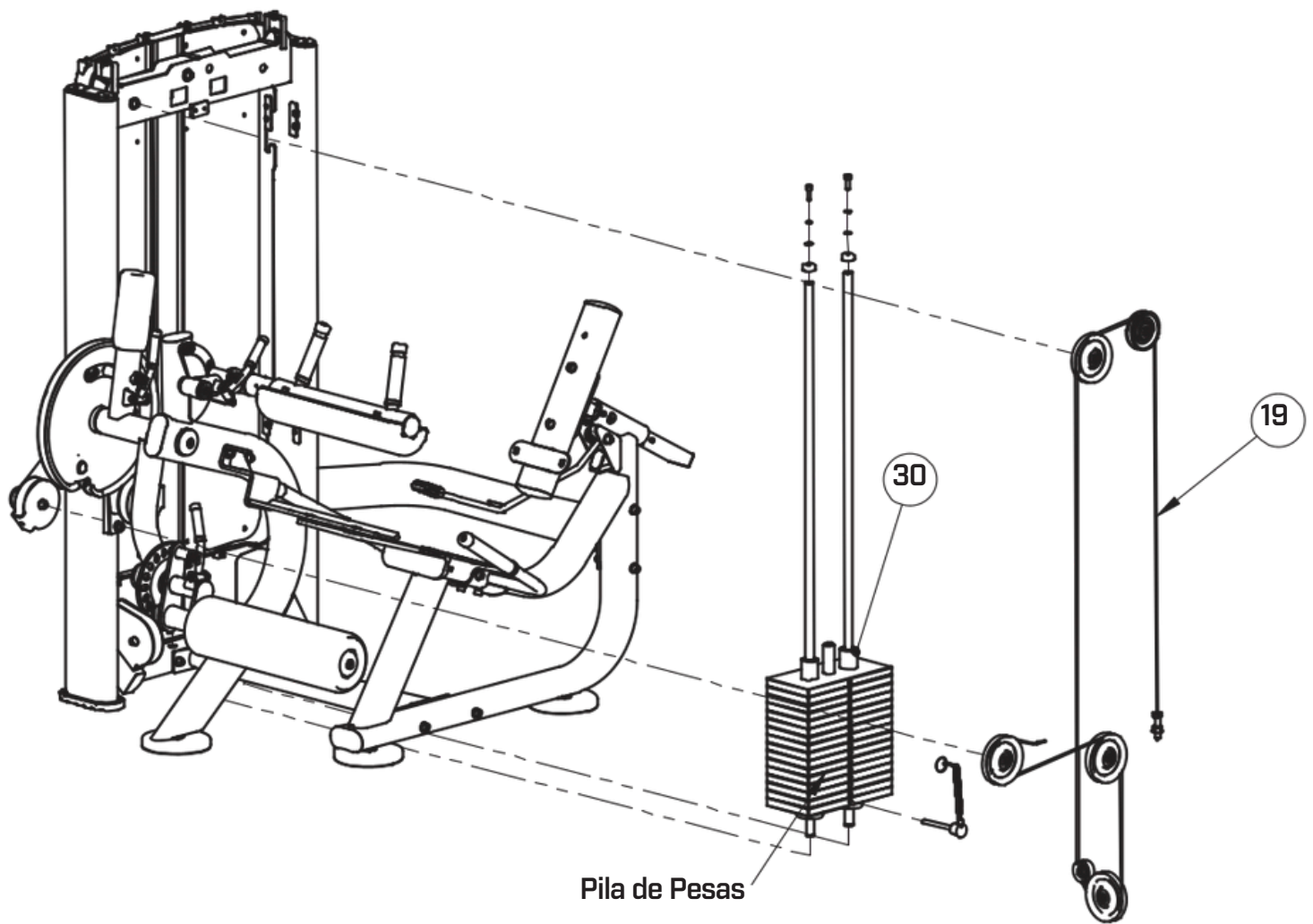

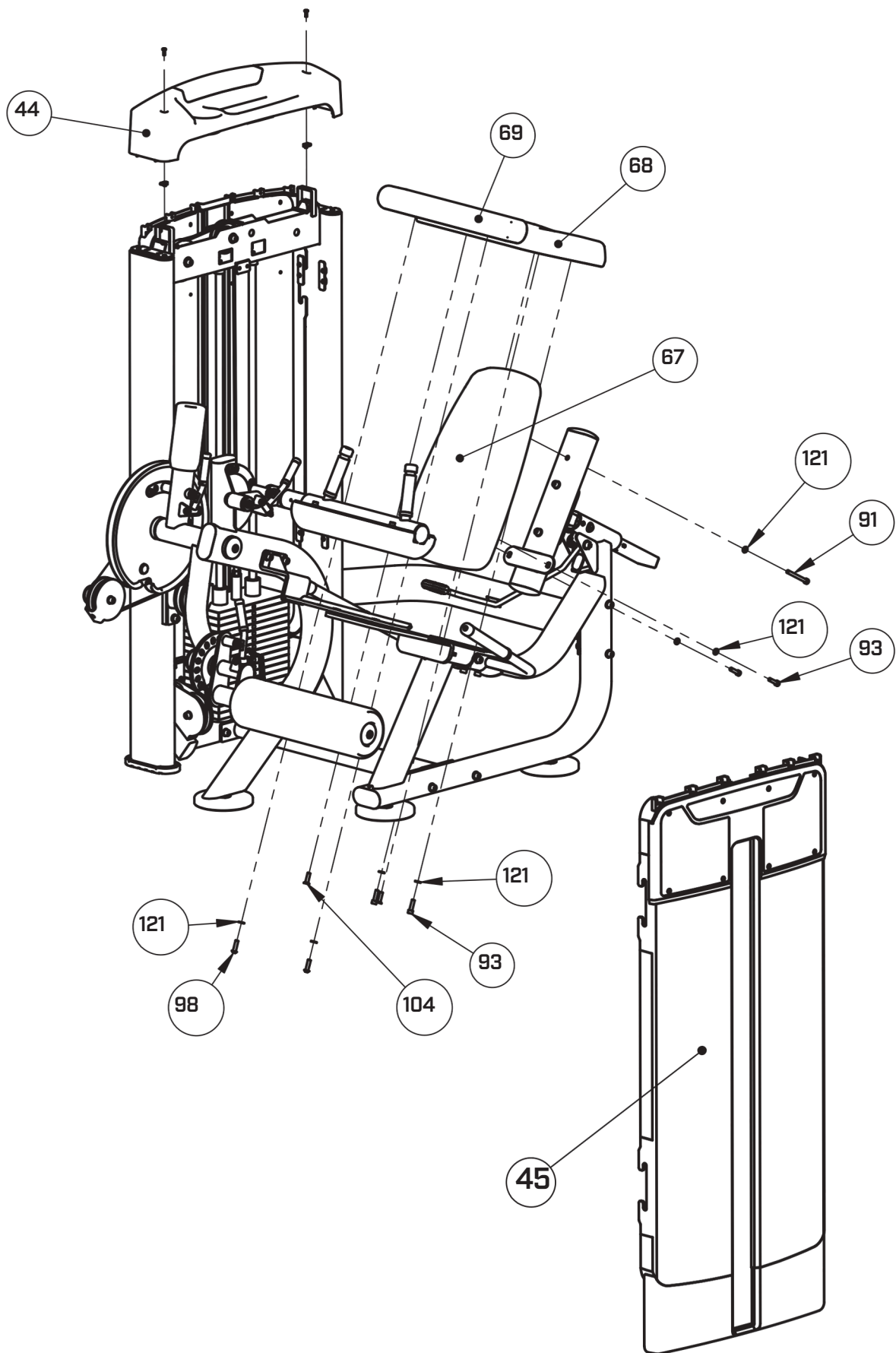

GARANTÍA

Para acceder al cambio o reparación establecida por la Garantía IRONSIDE por 12 meses, debes seguir estos pasos:

1. Ingreso del Ticket

- Si el producto presenta defectos, faltantes de piezas o no es apto para el uso, envía un correo con fotos y/o videos que evidencien la falla junto con tu número de pedido al mail de servicio al cliente del país en el que hiciste la compra (Argentina, Chile, EEUU o México). Nuestro equipo revisará tu caso y te dará una respuesta dentro de un plazo máximo de 3 días hábiles.

1. Soluciones

- Cambio: Si el producto tiene problemas de fábrica o faltan piezas esenciales, se realizará el cambio o envío de las piezas faltantes en un plazo de 3 a 5 días hábiles.
- Reparación: Si la falla corresponde a una pieza que puede ser reemplazada sin afectar el funcionamiento o la estética, se reparará y se despachará en 5 a 8 días hábiles.

1. Exclusiones de Garantía

- La garantía no cubre productos mal ensamblados, alterados, dañados por uso indebido o que hayan sufrido desgaste normal.

Nota: Los pedidos realizados antes del 15 de abril de 2024 tienen una garantía de 6 meses.

POWERFULL
GLAMOROUS
SMART
DURABLE

IRONSIDE®

FITNESS
EQUIPMENT
SPECIALISTS